



**STIHL**

www.stihl.com

**PolyCut 18-2**

0457-363-0174-B VA0.B23



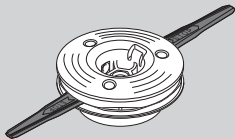

📷 A

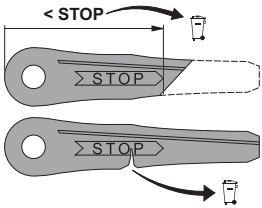

1

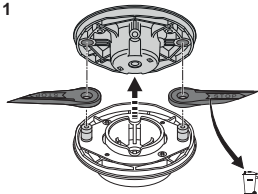

2

10 Nm / 89 lbf. in.

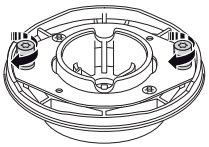

3

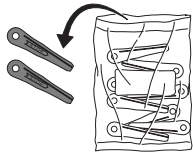

4002 007 1020

4

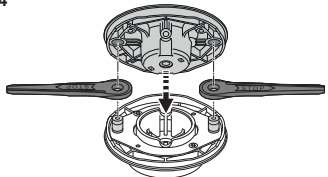

5

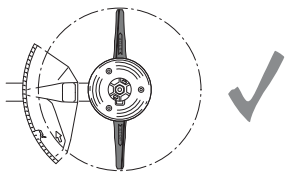

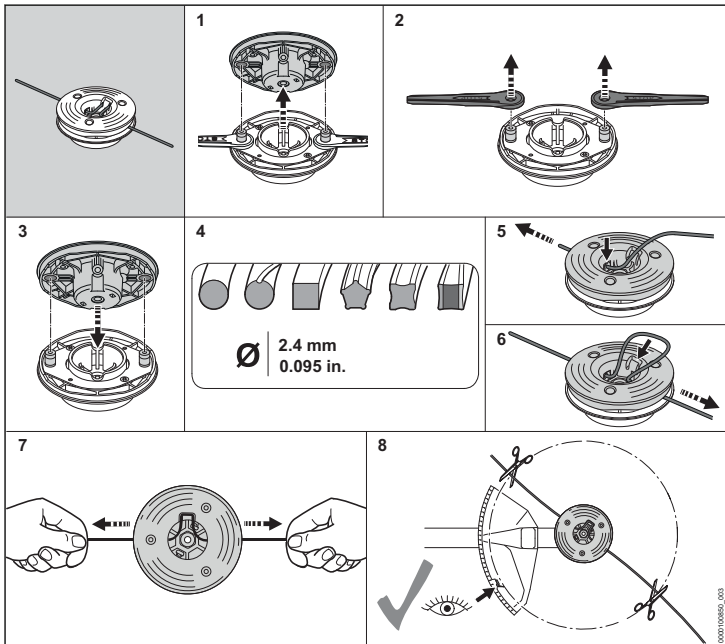

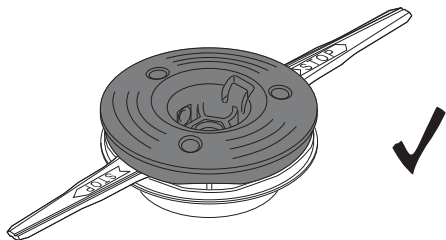

📷 B

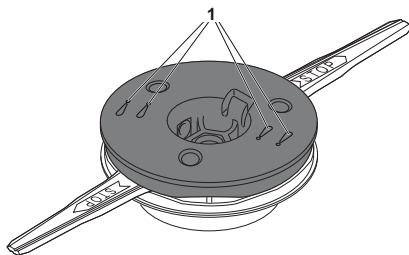

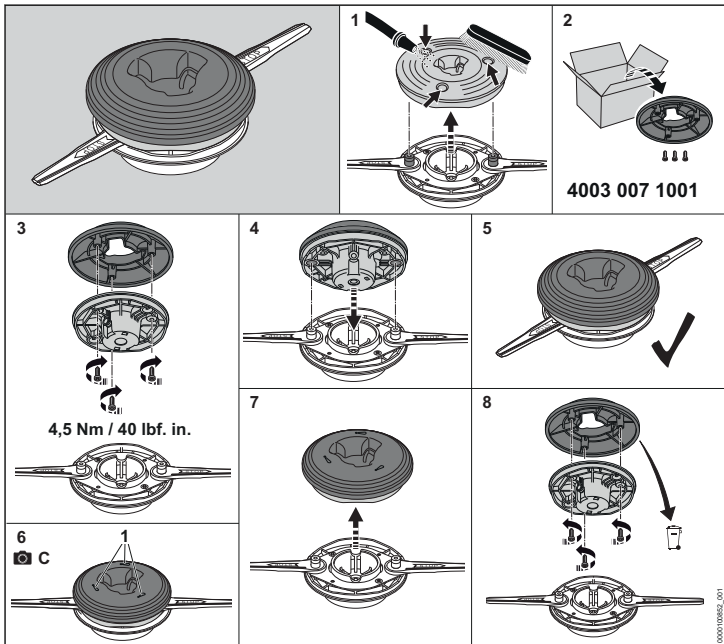

**D**

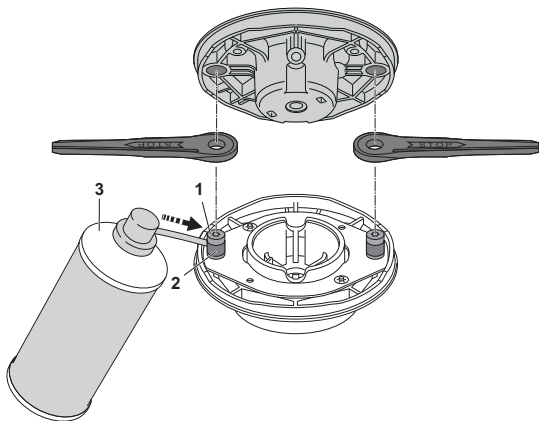

**E**

**10 Nm / 89 lbf. in.**

